

0 600 875 003

Stand } 02-02

Issue } 06-01-27

**Fig. /Abb. 3**

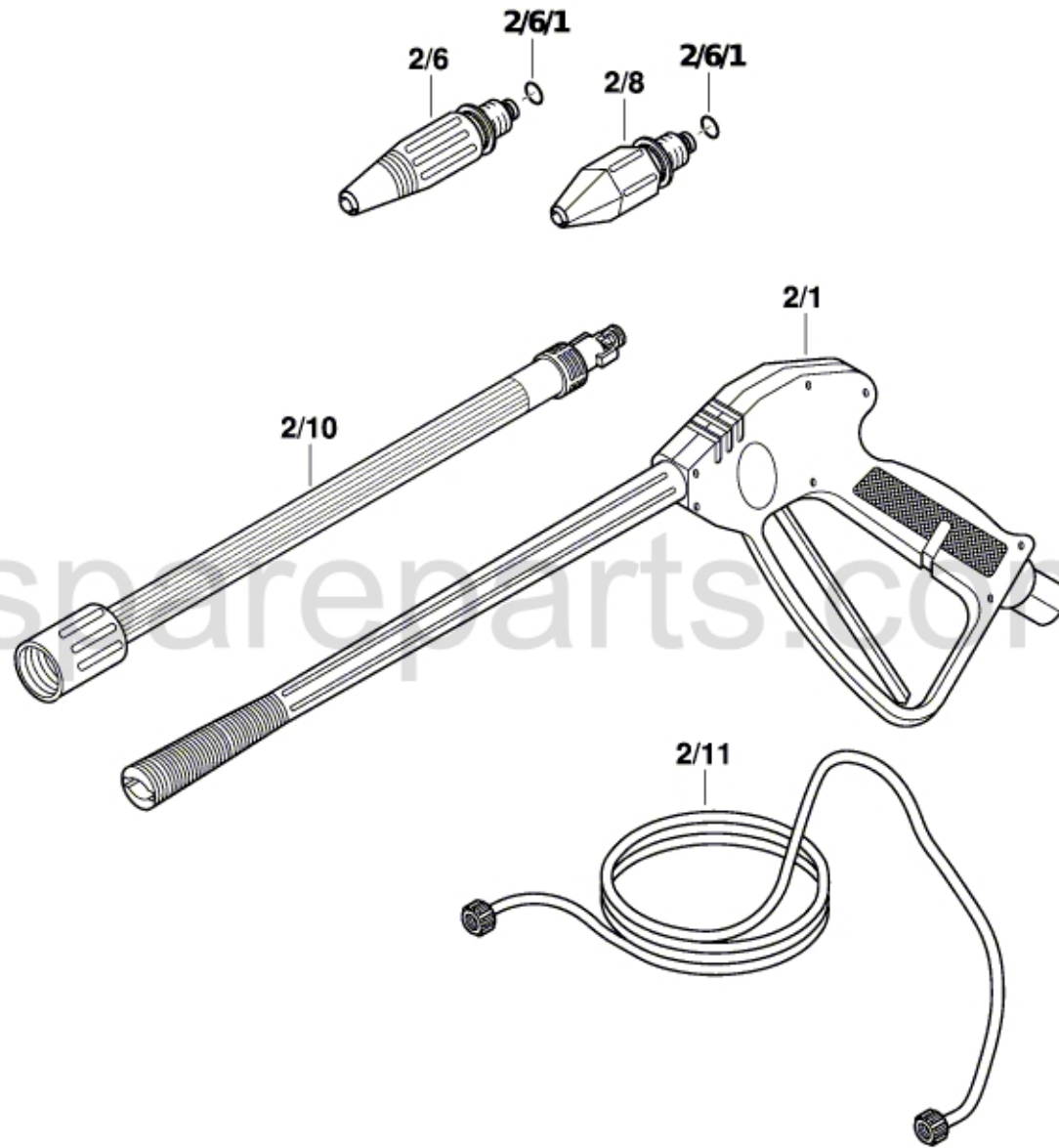

Änderungen vorbehalten  
Modifications reserved  
Modificacions reserves  
Salvo modificaciones